

Article number: 20907619

Description: E+G Ball point screw
GN 605-M6-20-VR

Measures

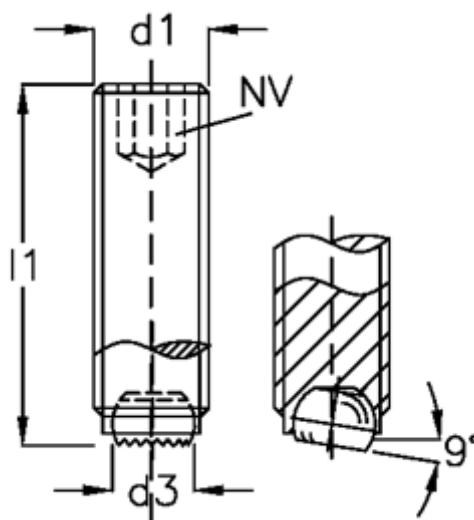

d1	= M6
d2	= 4.0
d3	= 3.2
Internal hexagon	= 3
l1	= 20